



# DEEP CYCLE AGM TECHNOLOGY

## LDC1250(50Ah/10HR)

### FEATURES & BENEFITS

- True deep cycle AGM technology-GREEN SOLUTION
- Over 99.99% virgin lead for grid plate and active material
- Heavy duty grid/paste design for deep cycle application
- Maintenance free, non-spillable, valve-regulated
- Double separator configuration:long cycle life & High energy density and super anti-vibration design
- Low self-discharge for longer shelf life



### ELECTRICAL SPECIFICATIONS

Voltage(V)	Capacity (AH)					Reserve Capacity (Min)		
	100HR	20HR	10HR	5HR	3HR	@25A	@56A	@75A
12	/	55	50	48	45	/	/	/

### PHYSICAL SPECIFICATIONS

Model	Dimensions (mm/inches)				Weight (kg/lbs)	Terminal Type (Standard)	Case Material
	Length	Width	Height	Total Height			
LDC1250	223(8.78)	123(4.84)	175 (6.89)	175 (6.89)	13.4 (29.54)	T12-A	ABS

Operating Temperature Range		
Discharge	Charge	Storage
-15°C ~ 50°C (5°F ~ 122°F)	0°C ~ 40°C (32°F ~ 104°F)	-15°C ~ 40°C (5°F ~ 104°F)

DEEP CYCLE AGM BATTERY

# LDC1250

## DIMENSIONS

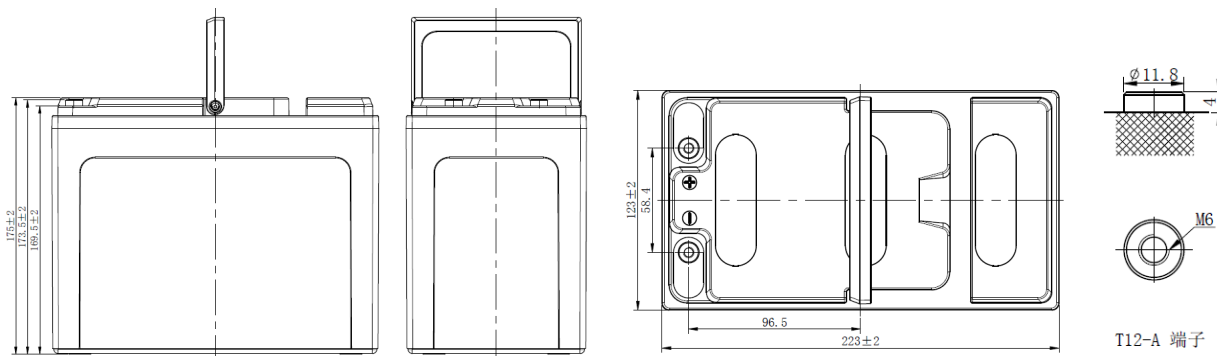

Note: Terminal Torque Values in-lb(Nm) :34.5-47.8(3.9-5.4)

## PERFORMANCE CHARACTERISTICS

### LEOCH LDC AGM Charging Profile

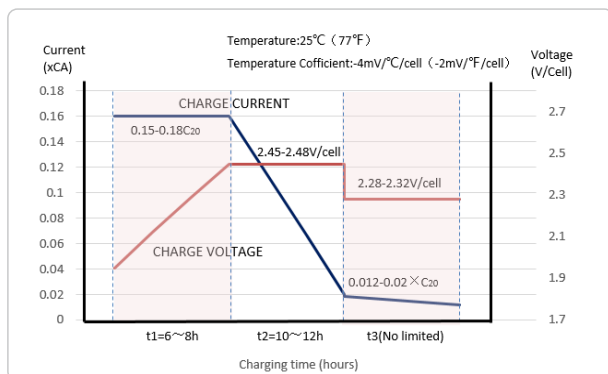

### Relationship of OCV and State Of Charge (25°C, 77°F)

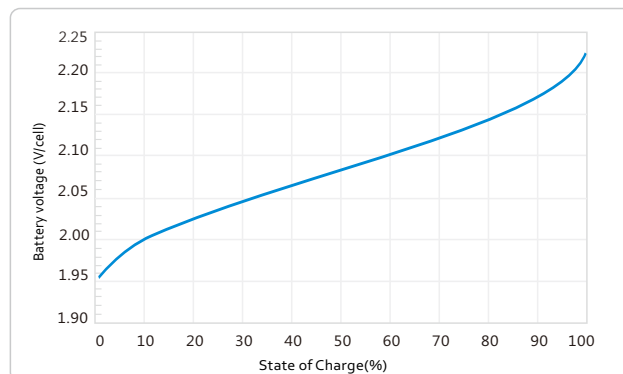

### Cycle life in relation to Depth Of Discharge

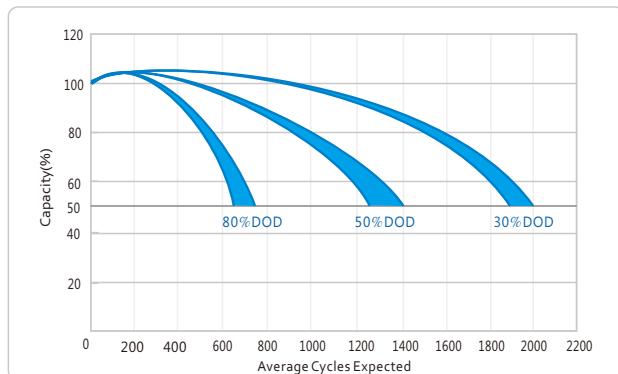

### Self-discharge Characteristic

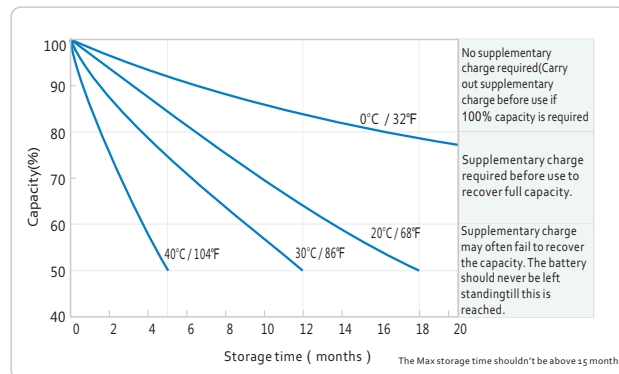

- LEOCH INTERNATIONAL SALES OFFICE:  
Add: 5th Floor, Xinbaohui Bldg.  
Nanhai Blvd, Nanshan, Shenzhen, China. 518054  
Tel: +86-755-86036060(100 lines) Fax: +86-755-26067269  
E-mail: export@leoch.com  
web: www.leoch.com